

**Display Elektronik GmbH**

# **DATA SHEET**

**TFT- MODULE**

**DEM 640480D TMH-PW-N**

**5,7" TFT**

**Product Specification**

**Ver.: 5**

**10.06.2015**



**Contents**

**1 General Description and Features**..... 4

    1.1 Features ..... 4

    1.2 LCD Module..... 4

**2 Mechanical Information**..... 4

**3 Electrical Specifications**..... 5

    3.1 Absolute Max. Ratings..... 5

    3.2 Electrical Characteristics..... 6

    3.3 AC Timing Characteristic of The LCD..... 7

    3.4 Back-Light Unit..... 10

**4 Optical Characteristics** ..... 11

    4.1 Optical characteristic of the LCD ..... 11

**5 Input Terminal Pin Assignment**..... 13

    5.1 Pin Assignment..... 13

    5.2 Back-light Unit (BLU)..... 13

    5.3 Block Diagram ..... 14

    5.4 Basic Display Color and Gray Scale ..... 15

**6 Reliability Condition** ..... 16

**7 Dimensional Outlines** ..... 17

**8 Incoming Inspection Standards** ..... 18

## 1 General Description and Features

DEM 640480D TMH-PW-N is a transmissive type color active matrix TFT (Thin Film Transistor) liquid crystal display (LCD) that uses amorphous silicon TFT as a switching device. This model is composed of a TFT-LCD module, a driver circuit and a back-light unit. Graphics and texts can be displayed on a VGA 640 (W) x 3 x 480 (H) dots with 262,144 colors by supplying 18 bits data signal (6bits/each color). The following table described the features of DEM 640480D TMH-PW-N.

### 1.1 Features

- ◆ Transmissive and Backlight with 30 LEDs are available
- ◆ TN (Twisted Nematic) Mode.
- ◆ LVDS (6-Bits/Color) Data Transfer
- ◆ Clock Signal: latching data at the falling edge.
- ◆ RoHS Compliance

### 1.2 LCD Module

Item	Specification	Unit
Screen Size	5.7 Inches	Diagonal
Display Resolution	640 x RGB x 480	Pixel
Active Area	115.20 x 86.40	mm
Outline Dimension	144.00 x 104.60 x 13.00	mm
Display Mode	Normally White Mode / Transmissive / Wide view	--
Pixel Arrangement	R,G,B Vertical Tripe	--
Pixel Size	0.1815 x 0.1815	mm
Display Color	262k Colors	--
Viewing Direction	6 o'clock (Gray inversion)	--
Input Interface	LVDS (6-Bits/Color) Data Transfer	--

## 2 Mechanical Information

Item		Min.	Typ.	Max.	Unit	Note
Module Size	Horizontal (H)	--	144.00	--	mm	(1)
	Vertical (V)	--	104.60	--	mm	(1)
	Thickness (T)	--	13.00	--	mm	(1)
Weight		--	(150)	--	g	--

Note (1) Excluding backlight cables. . Refer to the Outline Dimension Drawing as attached.

3 Electrical Specifications

3.1 Absolute Max. Ratings

3.1.1 Absolute Ratings of Environment

If the operating condition exceeds the following absolute maximum ratings, the TFT LCD module may be damaged permanently.

(Ta=25±2°C, VSS=GND=0)

Item	Symbol	Min.	Max.	Unit	Note
Storage Temperature	T <sub>STG</sub>	-30	80	°C	(1)
Operating Temperature	T <sub>OPR</sub>	-20	70	°C	(1,2,3)

Note (1) 95 % RH Max. ( 40°C ≥ Ta ). Maximum wet-bulb temperature at 39°C or less.  
(Ta > 40°C) No condensation.

Note (2) In case of below 0°C, the response time of liquid crystal (LC) becomes slower and the color of panel becomes darker than normal one. Level of retardation depends on temperature, because of LC's character

Note (3) Only operation is guarantied at operating temperature. Contrast, response time, another display quality are evaluated at +25°C.

3.1.2 Electrical Absolute Maximum Ratings

(VSS=GND=0)

Parameter	Symbol	Min.	Max.	Unit	Remark
Power supply voltage	V <sub>CC</sub>	-0.3	5.0	V	
Signal input voltage	R0-R5,G0-G5, B0-B5,DCLK,DE	-0.3	V <sub>CC</sub> +0.3	V	--
Permissive input ripple voltage	V <sub>RF</sub>	--	100	mVp-p	V <sub>CC</sub> = +3.3V

Display On/Off Sequence :

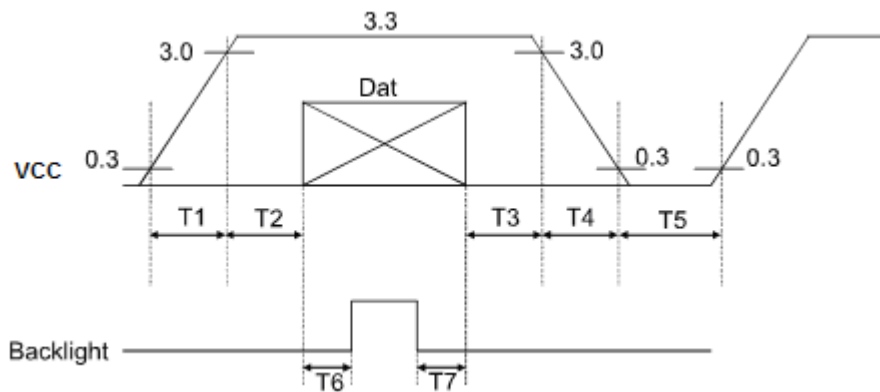

Data: DCLK, R0 ~ R5, G0 ~ G5, B0 ~ B5, DE

T1≤10ms, 50ms≤T2, 0<T3≤50ms, 0<T4≤10ms, 1s≤T5, 200ms≤T6, 200ms≤T7

**3.2 Electrical Characteristics**

3.2.1 DC Electrical Characteristics of the TFT LCD

(Ta=25±2°C, Vss=GND=0)

Item	Symbol	Min.	Typ.	Max.	Unit	Remark
Power Supply	VCC	3.0	3.3	3.6	V	Note 1
Input Voltage for Logic	H Level	0.7VCC	-	VCC	V	
	L Level	0	-	0.3VCC	V	
Power Supply Current	ICC		(120)	(160)	mA	Note 2

Note1: Vcc-dip conditions  
 Vcc-dip conditions should also follow the Vcc-turn-on conditions  
 $T_d \leq 10\text{ms}$

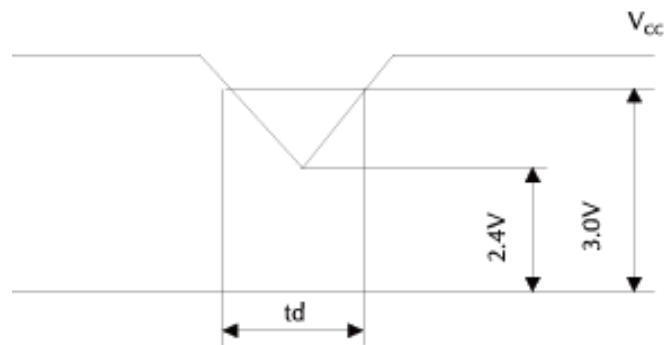

Note2: fv =60Hz, Ta=25°C, Display pattern: 64 Gray pattern

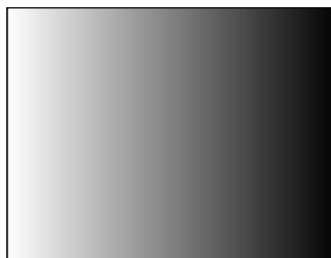

3.3 AC Timing Characteristic of The LCD

3.3.1 Timing Condition

Parameter	Symbol	Min.	Typ.	Max.	Unit.	Remark
CLK frequency	F <sub>CPH</sub>	22.66	25.175	27.69	MHZ	
CLK period	T <sub>CPH</sub>	36.11	39.7	44.13	ns	
CLK pulse duty	T <sub>CWH</sub>	40	50	60	%	
HS period	T <sub>H</sub>	750	800	850	T <sub>CPH</sub>	
HS pulse width	T <sub>WH</sub>	5	30	--	T <sub>CPH</sub>	
HS-first horizontal data time	T <sub>HS</sub>	112	144	175	T <sub>CPH</sub>	
Display period	T <sub>HA</sub>	--	640	--	T <sub>CPH</sub>	
HS setup time	T <sub>HST</sub>	10	--	--	ns	
HS hold time	T <sub>HHD</sub>	10	--	--	ns	
VS pulse width	T <sub>VW</sub>	1	3	5	T <sub>H</sub>	
First line data input time	T <sub>STV</sub>	--	35	--	T <sub>H</sub>	
VS period	T <sub>V</sub>	515	525	535	T <sub>H</sub>	
VS setup time	T <sub>VST</sub>	10	--	--	ns	
VS hold time	T <sub>VHD</sub>	10	--	--	ns	

Note: When SYNC mode is used, 1st data start from 144th CLK after HS falling (when STHD[5:0]=00000)

Parameter	Symbol	Min.	Typ.	Max.	Unit.	Remark
DEN Period	T <sub>DEN</sub>	--	800	--	T <sub>CPH</sub>	
DEN pulse width	T <sub>EP</sub>	--	640	--	T <sub>CPH</sub>	
DEN frame active time	T <sub>DEA</sub>	--	480	--	T <sub>DEN</sub>	
DEN frame blanking time	T <sub>DEB</sub>	--	45	--	T <sub>DEN</sub>	
DEN setup time	T <sub>ESU</sub>	10	--	--	ns	

3.3.2 Clock and Data input waveforms

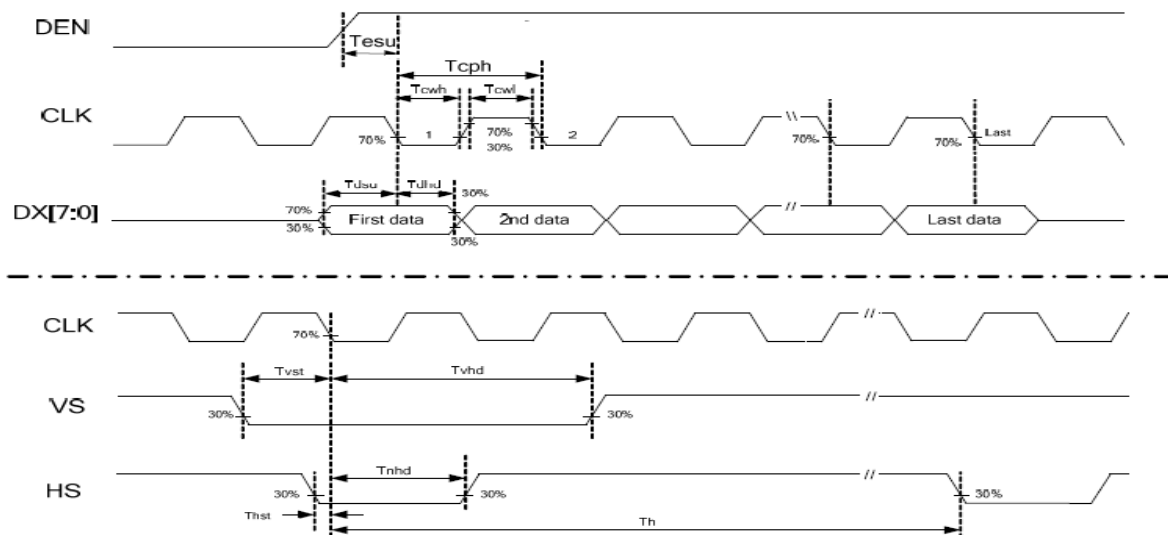

3.3.3 Parallel RGB SYNC Mode Horizontal Data Format



3.3.4 Parallel RGB DEN Mode Horizontal Data Format.

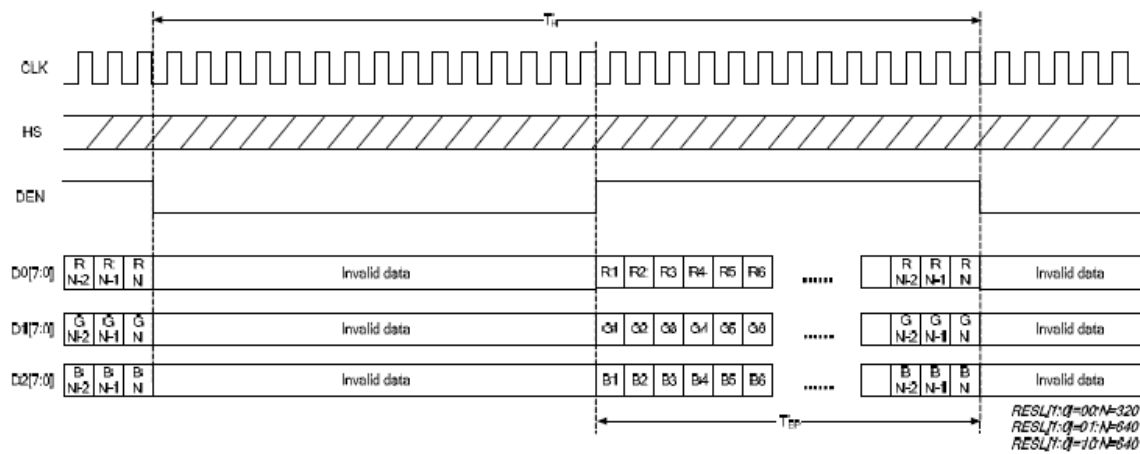

3.3.5 LVDS Timing Condition

$t_{RCP}$	CLK OUT Period	11.76	T	50.0	ns
$t_{RCH}$	CLK OUT High Time		$4T/7$		ns
$t_{RCL}$	CLK OUT Low Time		$3T/7$		ns
$t_{RCD}$	RCLK+/- to CLK OUT Delay		$5T/7$		ns
$t_{RS}$	TTL Data Setup to CLK OUT	$3T/7-2.5$			ns
$t_{RH}$	TTL Data Hold from CLK OUT	$4T/7-3.5$			ns
$t_{TLH}$	TTL Low to High Transition Time		3.0	5.0	ns
$t_{THL}$	TTL High to Low Transition Time		3.0	5.0	ns
$t_{RIP1}$	Input Data Position 0 (T=11.76ns)	-0.4	0.0	0.4	ns
$t_{RIP0}$	Input Data Position 1 (T=11.76ns)	$T/7-0.4$	$T/7$	$T/7+0.4$	ns
$t_{RIP6}$	Input Data Position 2 (T=11.76ns)	$2T/7-0.4$	$2T/7$	$2T/7+0.4$	ns
$t_{RIP5}$	Input Data Position 3 (T=11.76ns)	$3T/7-0.4$	$3T/7$	$3T/7+0.4$	ns
$t_{RIP4}$	Input Data Position 4 (T=11.76ns)	$4T/7-0.4$	$4T/7$	$4T/7+0.4$	ns
$t_{RIP3}$	Input Data Position 5 (T=11.76ns)	$5T/7-0.4$	$5T/7$	$5T/7+0.4$	ns
$t_{RIP2}$	Input Data Position 6 (T=11.76ns)	$6T/7-0.4$	$6T/7$	$6T/7+0.4$	ns
$t_{RPLL}$	Phase Lock Loop Set			10.0	ms



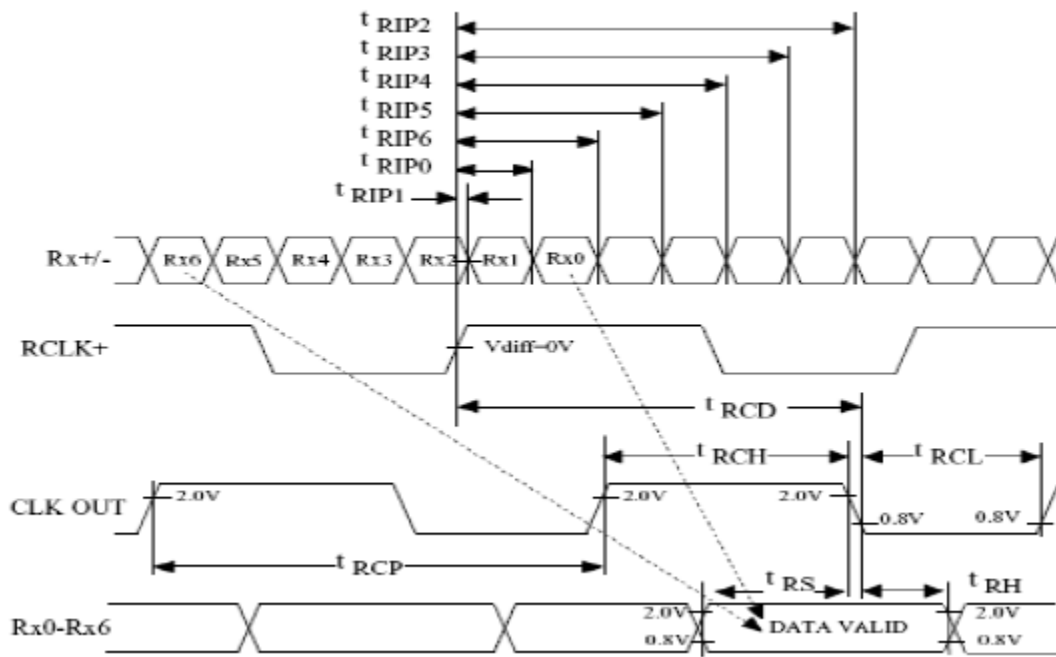

3.3.6 LVDS Data Mapping

	TA0	TA1	TA2	TA3	TA4	TA5	TA6	TB0	TB1	TB2	TB3	TB4	TB5	TB6	TC0	TC1	TC2	TC3	TC4	TC5	TC6
6BIT	R0	R1	R2	R3	R4	R5	G0	G1	G2	G3	G4	G5	B0	B1	B2	B3	B4	B5	HS	VS	DE

**3.4 Backlight Unit**

The Backlight system is an edge-lighting type with 30 white LEDs (Light Emitting Diode).  
The characteristics of 30 white LEDs are shown in the following tables.

(Ta= Room Temp)

Characteristics		Symbol	Min.	Typ.	Max.	Unit	Note
Current of Backlight Unit		$I_B$	-	200	250	mA	(1)
Voltage of Backlight Unit		$V_B$	-	(9.6)	(10.5)	V	
Power Consumption		$P_{BL}$	-	(1920)	(2625)	mW	(2)
LED Lifetime	25°C	-	(50000)			hr	(3)

Note (1) LEDS in 3 series x 10 parallel type.

(2) Where  $I_B = 200\text{mA}$ ,  $V_B = 9.6$ ,  $P_{BL} = V_B \times I_B$

(3) The environmental conducted under ambient air flow, at  $T_a=25\pm 2^\circ\text{C}$ ,  $60\%\text{RH}\pm 5\%$

## 4 Optical Characteristics

### 4.1 Optical Characteristic of the LCD

The following items are measured under stable conditions. The optical characteristics should be measured in a dark room or equivalent state.

Measuring equipment: BM-5A, BM-7

Item	Symbol	Condition	Min	Typ	Max	Unit	Note
Brightness			700	(900)	--	cd/m <sup>2</sup>	
Response Time	T <sub>r</sub>	θ=0°	-	15	20	ms	.
	T <sub>f</sub>		--	25	35	ms	
Contrast Ratio	CR	At optimized viewing angle	400	(500)	--	--	
Color Gamut	NTSC %	--	--	50	--	%	
Color Chromaticity (CIE 1931)	Red	R <sub>x</sub>	θ=0° Normal Viewing Angle	0.565	0.615	0.665	--
		R <sub>y</sub>		0.294	0.344	0.394	
	Green	G <sub>x</sub>		0.257	0.307	0.357	--
		G <sub>y</sub>		0.512	0.562	0.612	
	Blue	B <sub>x</sub>		0.090	0.140	0.190	--
		B <sub>y</sub>		0.080	0.130	0.180	
	White	W <sub>x</sub>		0.259	0.309	0.359	--
		W <sub>y</sub>		0.300	0.350	0.400	
Viewing Angle (6H)	Hor.	θ <sub>R</sub>	CR≥10	55	65	--	Degree
		θ <sub>L</sub>		55	65	--	
	Ver.	φ <sub>H</sub>		40	50	--	
		φ <sub>L</sub>		55	65	--	

#### a. Test equipment setup

After stabilizing and leaving the panel alone shall be warmed up for the stable operation of LCM, the measurement should be executed. Measurement should be executed in a stable, windless, and dark room. Optical specifications are measured by Topcon BM-7(fast) with a viewing angle of 2° at a distance of 50cm and normal direction.

#### b. Definition of response time: Tr and Tf

The response time is defined as the following figure and shall be measured by switching the input signal for "black" and "white".

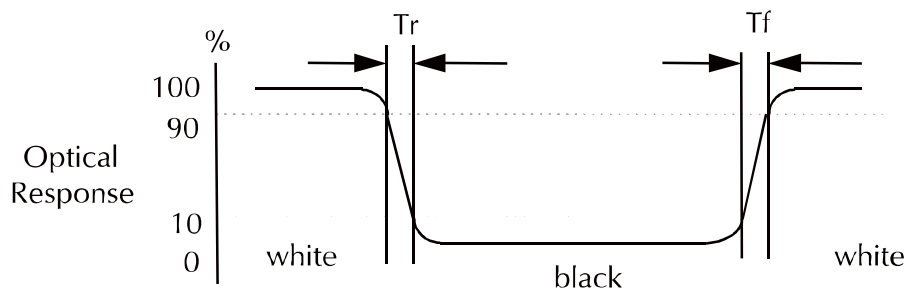

c. Definition of contrast ratio:

$$\text{Contrast Ratio (CR)} = \frac{\text{Brightness measured when LCD is at "white state"}}{\text{Brightness measured when LCD is at "black state"}}$$

d. Measured at the center area of the panel when all the input terminals of LCD panel are electrically opened.

e. View Angle

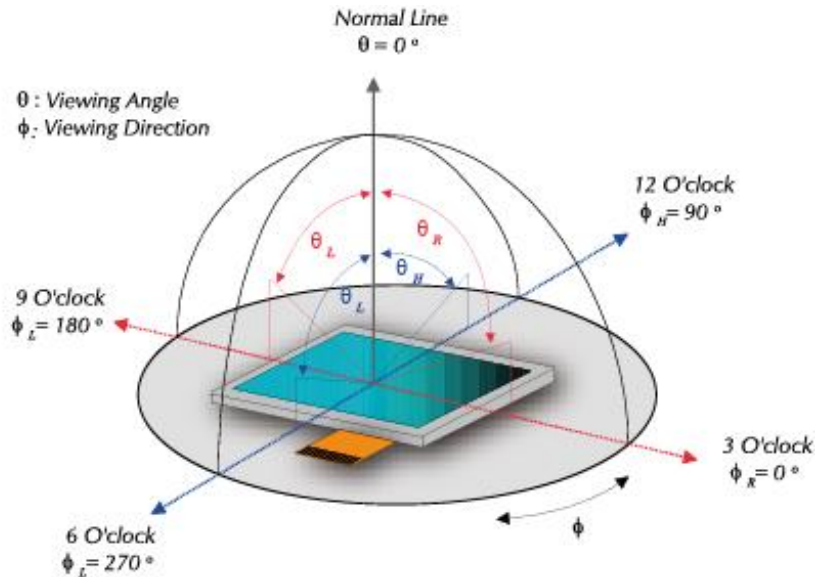

f. Definition of Luminance of White: Luminance of white at the center points

Light Source of Back-Light Unit	LED Type
---------------------------------	----------

g. Definition of White Uniformity

$$\text{White Uniformity} = \frac{\text{Min. luminance of white among 9-points}}{\text{Max. luminance of white among 9-points}}$$

h. The definition of Color Gamut -Color Chromaticity CIE 1931

Color coordinate of white & red, green, blue at center point.

$$\text{Color Gamut : NTSC(\%)} = ( \text{RGB Triangle Area} / \text{NTSC Triangle Area} ) \times 100$$

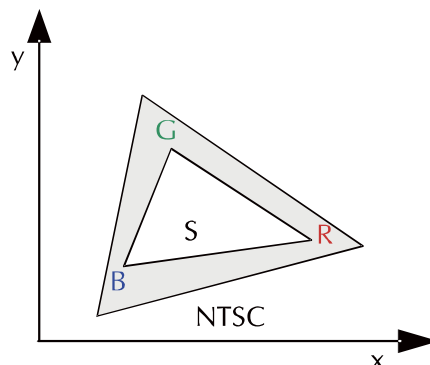

## 5 Input Terminal Pin Assignment

### 5.1 Pin Assignment

Pin No.	Symbol	I/O	Function	Remark
1	VCC	P	Power Supply 3.3V	
2	VCC	P	Power Supply 3.3V	
3	VSS	P	Ground	
4	VSS	P	Ground	
5	RXIN0-	I	LVDS Data Differential Pair 0 input	
6	RXIN0+	I	LVDS Data Differential Pair 0 input	
7	VSS	P	Ground	
8	RXIN1-	I	LVDS Data Differential Pair 1 input	
9	RXIN1+	I	LVDS Data Differential Pair 1 input	
10	VSS	P	Ground	
11	RXIN2-	I	LVDS Data Differential Pair 2 input	
12	RXIN2+	I	LVDS Data Differential Pair 2 input	
13	VSS	P	Ground	
14	RXCLK-	I	LVDS Clock Differential input	
15	RXCLK+	I	LVDS Clock Differential input	
16	VSS	P	Ground	
17	NC	-	NC	
18	NC	-	NC	
19	REV	I	Select horizontal and vertical scanning direction.	Note 1
20	VSS	P	Ground	

### 5.2 Backlight Unit (BLU)

Pin No.	Symbol	Function	Remark
1	LEDA	Power Supply for LED backlight	Red
2	LEDK	GND for LED backlight	Black

Connector: JST BHSR-02VS-1

5.3 Block Diagram

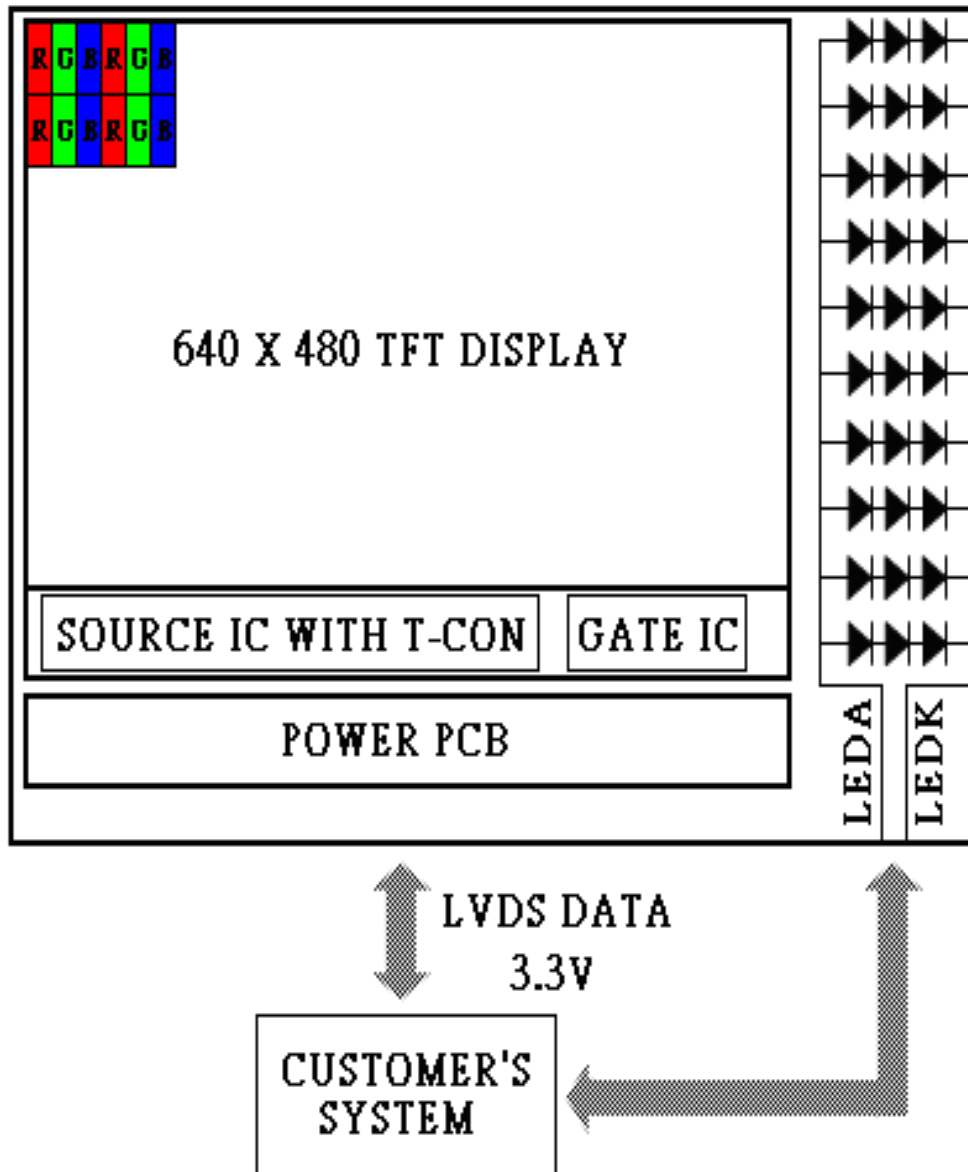

5.4 Basic Display Color and Gray Scale

	Color & Gray Scale	Data Signal																	
		R5	R4	R3	R2	R1	R0	G5	G4	G3	G2	G1	G0	B5	B4	B3	B2	B1	B0
Basic Color	Black	0	0	0	0	0	0	0	0	0	0	0	0	0	0	0	0	0	0
	Red(0)	1	1	1	1	1	1	0	0	0	0	0	0	0	0	0	0	0	0
	Green(0)	0	0	0	0	0	0	1	1	1	1	1	1	0	0	0	0	0	0
	Blue(0)	0	0	0	0	0	0	0	0	0	0	0	0	1	1	1	1	1	1
	Cyan	0	0	0	0	0	0	1	1	1	1	1	1	1	1	1	1	1	1
	Magenta	1	1	1	1	1	1	0	0	0	0	0	0	1	1	1	1	1	1
	Yellow	1	1	1	1	1	1	1	1	1	1	1	1	0	0	0	0	0	0
	White	1	1	1	1	1	1	1	1	1	1	1	1	1	1	1	1	1	1
Red	Black	0	0	0	0	0	0	0	0	0	0	0	0	0	0	0	0	0	0
	Red(62)	0	0	0	0	0	1	0	0	0	0	0	0	0	0	0	0	0	0
	Red(61)	0	0	0	0	1	0	0	0	0	0	0	0	0	0	0	0	0	0
	:	:	:	:	:	:	:	:	:	:	:	:	:	:	:	:	:	:	:
	Red(31)	0	1	1	1	1	1	0	0	0	0	0	0	0	0	0	0	0	0
	:	:	:	:	:	:	:	:	:	:	:	:	:	:	:	:	:	:	:
	Red(1)	1	1	1	1	1	0	0	0	0	0	0	0	0	0	0	0	0	0
	Red(0)	1	1	1	1	1	1	0	0	0	0	0	0	0	0	0	0	0	0
Green	Black	0	0	0	0	0	0	0	0	0	0	0	0	0	0	0	0	0	0
	Green(62)	0	0	0	0	0	0	0	0	0	0	0	1	0	0	0	0	0	0
	Green(61)	0	0	0	0	0	0	0	0	0	0	1	0	0	0	0	0	0	0
	:	:	:	:	:	:	:	:	:	:	:	:	:	:	:	:	:	:	:
	Green(31)	0	0	0	0	0	0	0	1	1	1	1	0	0	0	0	0	0	0
	:	:	:	:	:	:	:	:	:	:	:	:	:	:	:	:	:	:	:
	Green(1)	0	0	0	0	0	0	1	1	1	1	1	0	0	0	0	0	0	0
	Green(0)	0	0	0	0	0	0	1	1	1	1	1	1	0	0	0	0	0	0
Blue	Black	0	0	0	0	0	0	0	0	0	0	0	0	0	0	0	0	0	0
	Blue(62)	0	0	0	0	0	0	0	0	0	0	0	0	0	0	0	0	0	1
	Blue(61)	0	0	0	0	0	0	0	0	0	0	0	0	0	0	0	0	1	0
	:	:	:	:	:	:	:	:	:	:	:	:	:	:	:	:	:	:	:
	Blue(31)	0	0	0	0	0	0	0	0	0	0	0	0	0	1	1	1	1	1
	:	:	:	:	:	:	:	:	:	:	:	:	:	:	:	:	:	:	:
	Blue(1)	0	0	0	0	0	0	0	0	0	0	0	0	1	1	1	1	1	0
	Blue(0)	0	0	0	0	0	0	0	0	0	0	0	0	1	1	1	1	1	1

0: Low level voltage, 1 :High level voltage

Each basic color can be displayed in 64 gray scales from 6 bit data signals. With the combination of total 18 bit data signals, the 262,144-color display can be achieved on the screen.

**6 Reliability Condition**

No change on display and in operation under the following test condition.

Condition: Unless otherwise specified, tests will be conducted under the following condition.

Temperature: 20±5°C                      Humidity: 65±5%RH

Tests will be not conducted under functioning state.

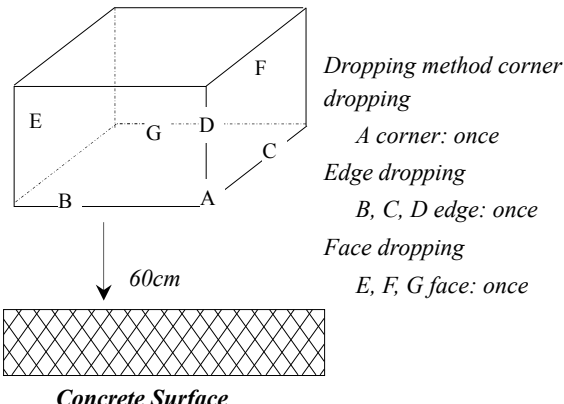
No.	Parameter	Condition	Notes
1	High Temperature Operating	70°C±2°C, 240hrs (Operation state)	-
2	Low Temperature Operating	-20°C±2°C, 240hrs (Operation state)	-
3	High Temperature Storage	80°C±2°C, 240hrs	-
4	Low Temperature Storage	-30°C±2°C, 240hrs	-
5	High Temperature and High Humidity Operation Test	60°C±2°C, 90%, 240hrs.	-
6	Vibration Test	Total fixed amplitude: 1.5mm Vibration Frequency: 10~55Hz One cycle 60 seconds to 3 direction of X, Y, Z each 15 minutes.	-
7.	Drop Test	To be measured after dropping from 60cm high on the concrete surface in packing state.  	-



7 Dimensional Outlines

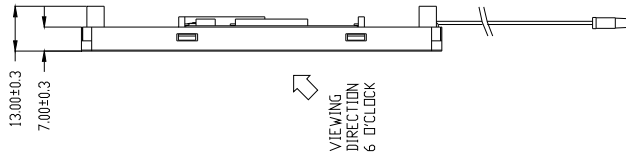
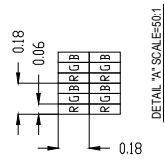
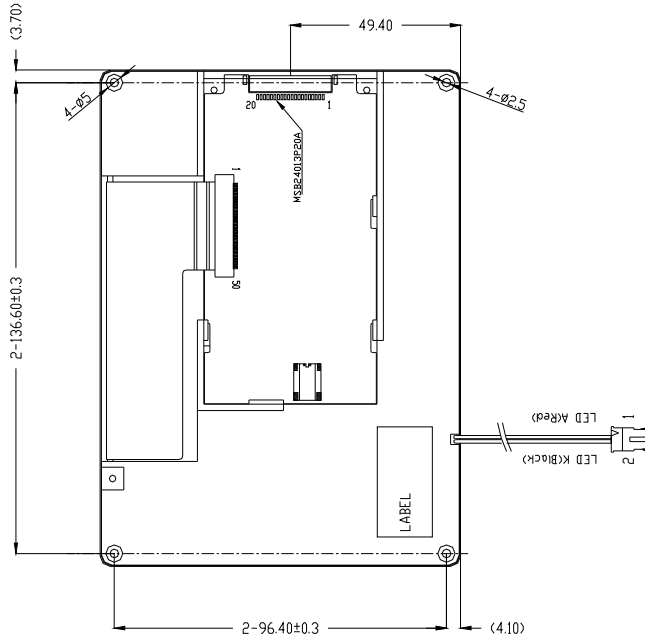

No:	PIN NAME	11	RIN2-
1	VCC	12	RIN2+
2	VCC	13	VSS
3	VSS	14	RCLK-
4	VSS	15	RCLK+
5	RIN0-	16	VSS
6	RIN0+	17	NC
7	VSS	18	NC
8	RIN1-	19	REV
9	RIN1+	20	VSS
10	VSS		

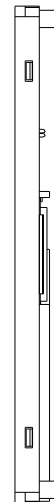
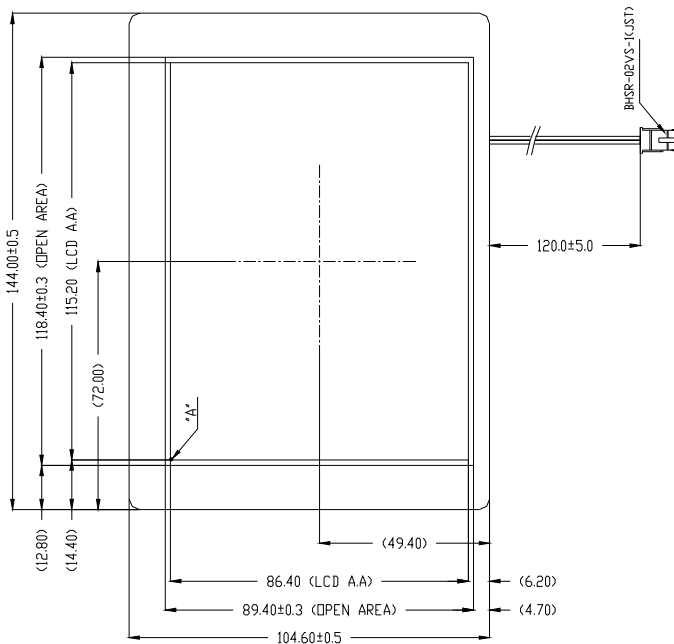

**8 Incoming Inspection Standards**

**8.1 Inspection and Environment Conditions**

8.1.1 Inspection Conditions:

- (1) Inspection Distance: 35 cm±5cm
- (2) View Angle : Light-on Inspection Angle : ±5°  
Cosmetic Inspection Angle : ±45°

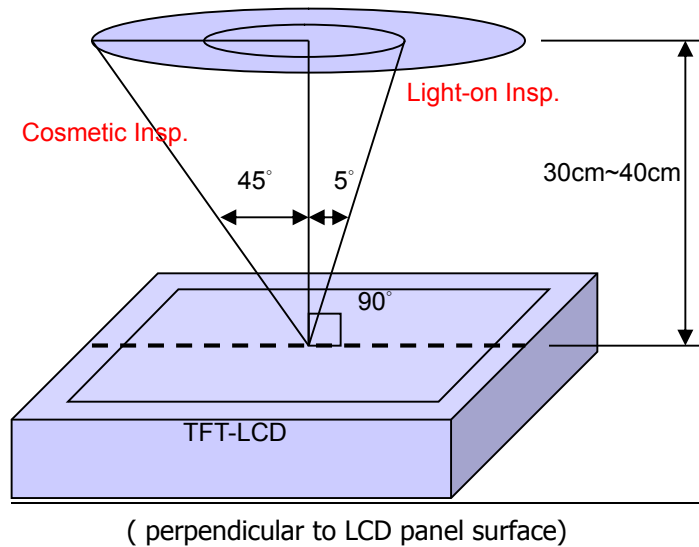

8.1.2 Environment Conditions:

Ambient Temperature		23°C±5°C
Ambient Humidity		55±10%RH
Ambient Illumination	Cosmetic Inspection	more than 600 Lux
	Functional Inspection	300~500 Lux

8.1.3 Sampling Conditions:

- (1) Lot Size: Quantity of shipment lot per model
- (2) Sampling Method:

Sampling Plan		MIL-STD-105E
		Normal Inspection, Single Sampling Level II
AQL	Major Defect	1.0%
	Minor Defect	1.5%

(3) The classification of Major(MA) and Minor(MI) defects is shown as 3. Inspection Criteria.

8.1.4 Inspection Criteria

8.1.4.1 Cosmetic Inspection(Panel):

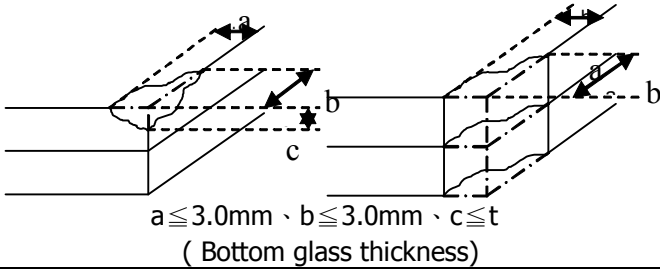
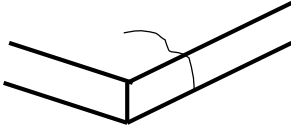
Item	Judgment Criteria	Classification
Chipping on Panel	 <p><math>a \leq 3.0\text{mm} \cdot b \leq 3.0\text{mm} \cdot c \leq t</math> ( Bottom glass thickness)</p>	MA
Scratch on Panel *Note-2	<p><math>W \leq 0.05\text{mm}</math> or <math>L &lt; 5\text{mm}</math>: Ignored  <math>0.05\text{mm} &lt; W \leq 0.1\text{mm}</math> and <math>L \leq 5\text{mm}</math>: <math>N \leq 5</math>  <math>W &gt; 0.1\text{mm}</math> or <math>L &gt; 5\text{mm}</math>: Not allowed</p>	MI
Bubble or Dent on Panel *Note-3	<p><math>D \leq 0.2\text{mm}</math>: Ignored  <math>0.2\text{mm} &lt; D \leq 0.3\text{mm}</math>: <math>N \leq 5</math>  <math>D &gt; 0.3\text{mm}</math>: Not allowed</p>	MI
Panel Crack	 <p>Not Allowed crack</p>	MA
Bezel Deformation	Obvious deformation is not allowed.	MI
Bezel Oxidation	Not allowed if it rusts continuously over 1 cm (It is out of warranty with rusted tin plate)	MI
Bezel Scratch	$L \leq 20\text{mm}$ , $W \leq 0.2$ , $N \leq 3$	MI
Metal Squash Dent /Flange(Front Side)	$D(W) \leq 1, L \leq 3, N \leq 3;$	MI
B/L High Voltage Wire Denudation	Not allowed	MA
Polarizer flaw or leak out resin	Defect is defined as the active area.	MI
Outline Dimension	Must in Spec, refer to related product spec.	MI

8.1.4.2 Functional Inspection:

Item	Judgment Criteria			Classification
	Area(Note1)	I	O	
Point Defect	Bright dot	Random	2	
		2 dots adjacent	0	0
		3 dots adjacent or more	0	0
	Dark dot	Random	3	
		2 dots adjacent	0	
		3 dots adjacent or more	0	0
	Total Dot Defect		5	
	Distance	Distance between Bright and Bright dot	$L \geq 5\text{mm}$	
		Distance between Bright and Dark dot	$L \geq 5\text{mm}$	
		Distance between Dark dot	$L \geq 5\text{mm}$	
(1) It is defined as Point Defect if defect area $> 0.5\text{dot}$ (2) It is ignored if defect area $\leq 0.5\text{dot}$ (3) Weak point defect will be defined as Bright Dot if it can be observed through ND filter 5%( Full Screen Black Inspection)				MI
Line Defect	Obvious vertical or horizontal line defect is not allowed.			
Mura	Not allowed if it can be observed through ND Filter 5 %			
Foreign Material in spot shape *Note-3	$D \leq 0.2\text{mm}$ : Ignored $0.2\text{mm} < D \leq 0.5\text{mm}$ : $N \leq 8$ $D > 0.5\text{mm}$ : Not allowed			
Foreign Material in line or spiral shape *Note-4	$W \leq 0.05\text{mm}$ or $L \leq 5\text{mm}$ : Ignored $0.05\text{mm} < W \leq 0.2\text{mm}$ and $L 1.0\text{mm} \leq 5\text{mm}$ : $N \leq 8$ $W > 0.2\text{mm}$ or $L > 5\text{mm}$ : Not allowed			
Display Function Abnormal	No Malfunction can be allowed			

Note-1 : I/O Area Definition

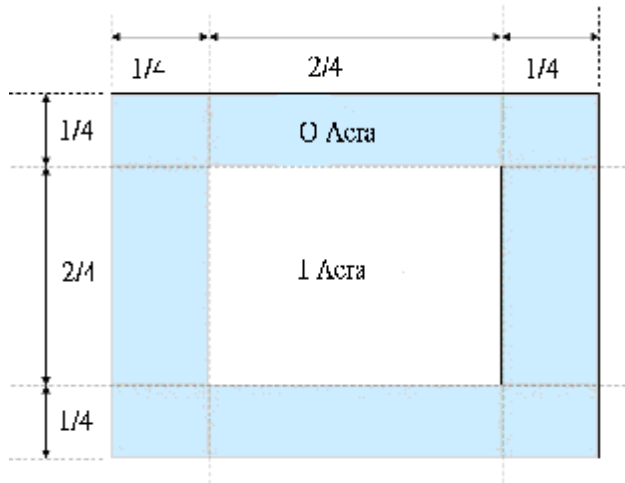

Note-2 : Polarizer Scratch

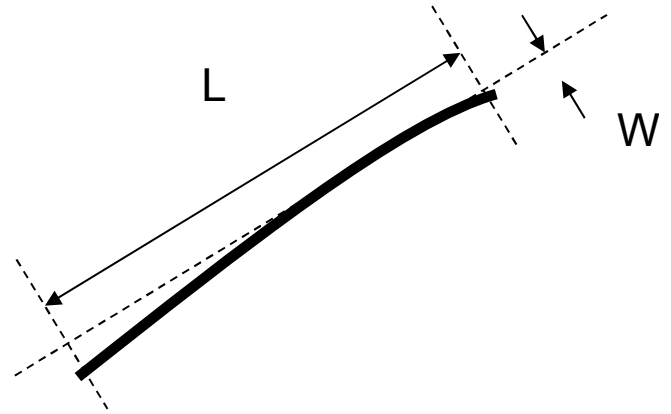

Note-3 : Spot Foreign Material  
( $W \geq L / 4$ )

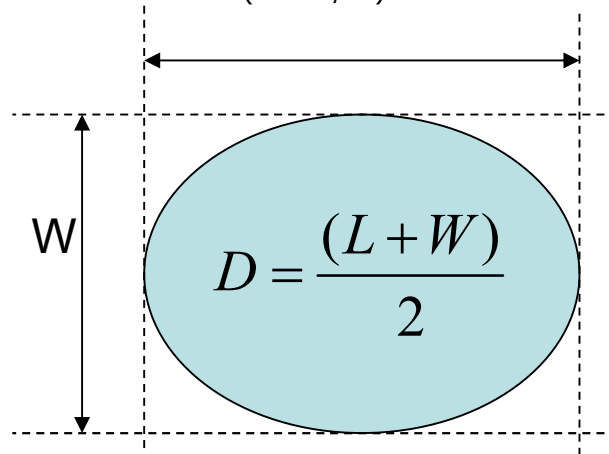

Note-4 : Line or Spiral Foreign Material  
( $W < L / 4$ )

