

Display Elektronik GmbH

# DATA SHEET

***LCD-MODULE***

## **DEM 240064E SBH-PW-N**

Product Specification

Ver.: 3

29.09.2019

## Revision History

<b>VERSION</b>	<b>DATE</b>	<b>REVISED PAGE NO.</b>	<b>Note</b>
0	01.09.2014		First issue
1	25.02.2016		Modify Precautions in use of LCD Modules & Static electricity test
2	01.12.2016		Add FPC bending rule
3	29.09.2019		Modify Material List of Components for RoHs

# **Contents**

- 1.General Specification
- 2.Interface Pin Function
- 3.Contour Drawing &Block Diagram
- 4.Optical Characteristics
- 5.Absolute Maximum Ratings
- 6.Electrical Characteristics
- 7.Backlight Information
- 8.Reliability
- 9.Inspection specification
- 10.Precautions in use of LCD Modules
- 11.Material List of Components for RoHs
- 12.Recommendable Storage
- 13.Other

## **1. General Specification**

The Features is described as follow:

- n Module dimension: 86.20 x 39.30 x 5.10 mm
- n View area: 80.80 x 24.80 mm
- n Active area: 76.78 x 20.46 mm
- n Number of dots: 240 x 64
- n Dot size: 0.30 x 0.30 mm
- n Dot pitch: 0.32 x 0.32 mm
- n LCD type: STN Negative, Blue Transmissive
- n Duty: 1/64
- n View direction: 6 o'clock
- n Backlight Type: LED, White
- n IC: ST7586S

## 2. Interface Pin Function

Pin No.	Symbol	I/O	Description																				
1	VG	P	VG is the power of SEG-drivers.																				
2	XV0	P	Negative operating voltage of COM-drivers.																				
3	V0	P	Positive operating voltage of COM-drivers. V0O is the output of the positive Vop generator. V0I is the positive Vop supply of LCD drivers. V0S is the sensor of the positive Vop generator. V0O, V0I & V0S should be separated on ITO and be connected together by FPC.																				
4	VM	P	VM is the non-select voltage level of COM-drivers.																				
5	VDDA	P	Analog power for internal booster.																				
6	VSS	P	Ground																				
7	VD1	P	VD1I is the power source of digital circuits.																				
8	VDDI	P	Power of interface I/O circuit.																				
9	CSB	Input	Chip select input pin. CSB="L": This chip is selected and the MPU interface is active.																				
10	IF3	Input	These pins select interface operation mode. <table border="1" data-bbox="499 1518 1173 1765"> <thead> <tr> <th>IF3</th> <th>IF2</th> <th>IF1</th> <th>MPU interface type</th> </tr> </thead> <tbody> <tr> <td>H</td> <td>H</td> <td>L</td> <td>80 series 8-bit parallel</td> </tr> <tr> <td>H</td> <td>L</td> <td>L</td> <td>68 series 8-bit parallel</td> </tr> <tr> <td>L</td> <td>H</td> <td>H</td> <td>8-bit serial (4-Line)</td> </tr> <tr> <td>L</td> <td>H</td> <td>L</td> <td>9-bit serial (3-Line)</td> </tr> </tbody> </table> Note: Refer to "Interface Selection" for detailed information.	IF3	IF2	IF1	MPU interface type	H	H	L	80 series 8-bit parallel	H	L	L	68 series 8-bit parallel	L	H	H	8-bit serial (4-Line)	L	H	L	9-bit serial (3-Line)
IF3	IF2			IF1	MPU interface type																		
H	H			L	80 series 8-bit parallel																		
H	L			L	68 series 8-bit parallel																		
L	H	H	8-bit serial (4-Line)																				
L	H	L	9-bit serial (3-Line)																				
11	IF2																						
12	IF1																						
13	RSTB	Input	Reset input pin. When RSTB is "L", internal initialization procedure is executed.																				
14	/RD(E)	Input	Read / Write execution control pin. (This pin is only used in parallel interface)																				
15	D7	I/O	The bi-directional data bus of the MPU interface. When CSB is "H", they are high impedance.																				

16	D6		If using serial interface: D0 is the SDA signal in 4-Line & 3-Line interface. D1 is the A0 signal in 4-Line interface
17	D5		
18	D4		
19	D3		
20	D2		
21	D1		
22	D0		
23	NC		No connection
24	/WR(R/W)	Input	Read / Write execution control pin. (This pin is only used in parallel interface)
25	A0(SCL)	Input	The function of this pin is different in parallel and serial interface. In parallel interface: A0 is register selection input.
26	VSS	P	Ground

### 3. Contour Drawing

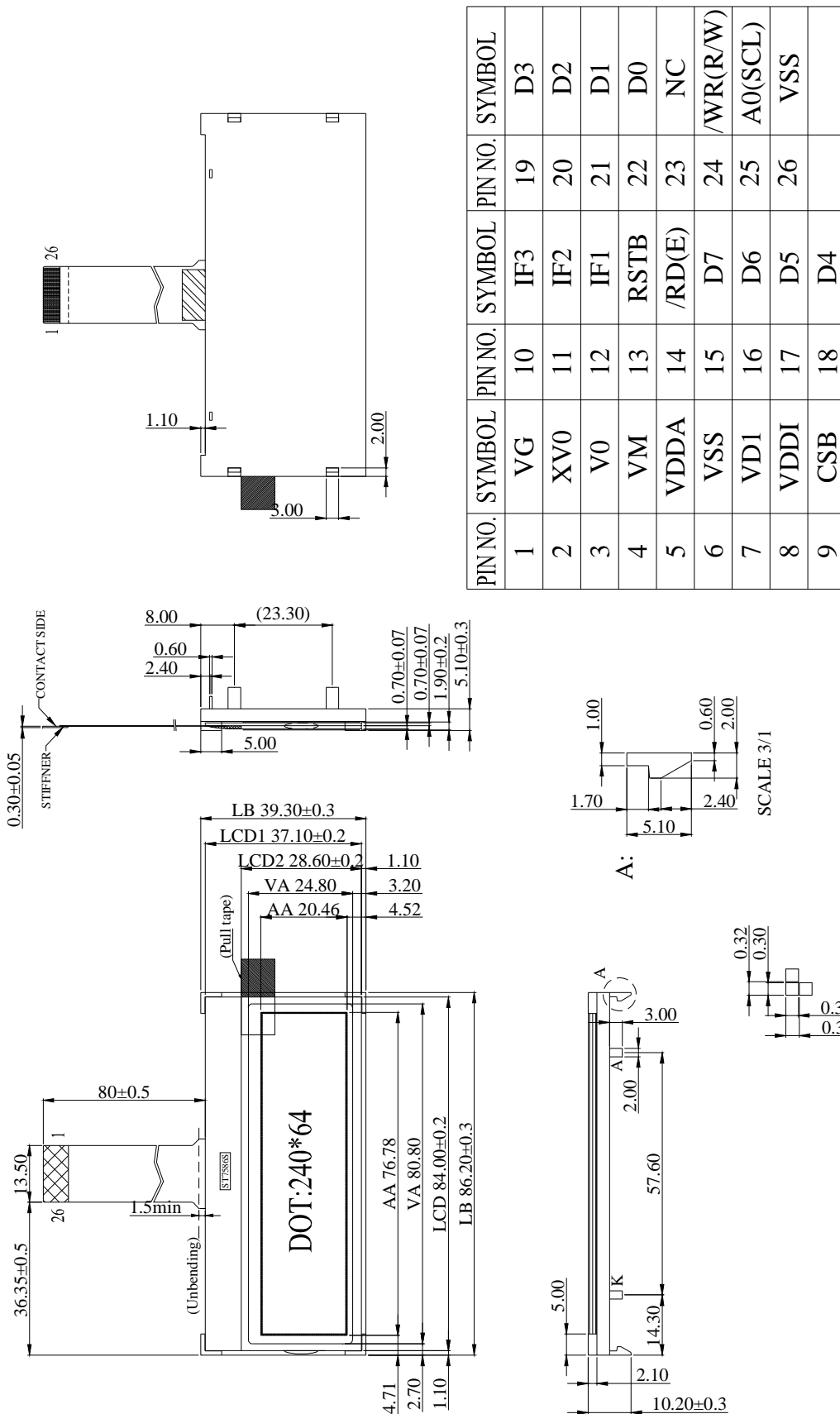

The non-specified tolerance of dimension is  $\pm 0.3$  mm .

# Application schematic

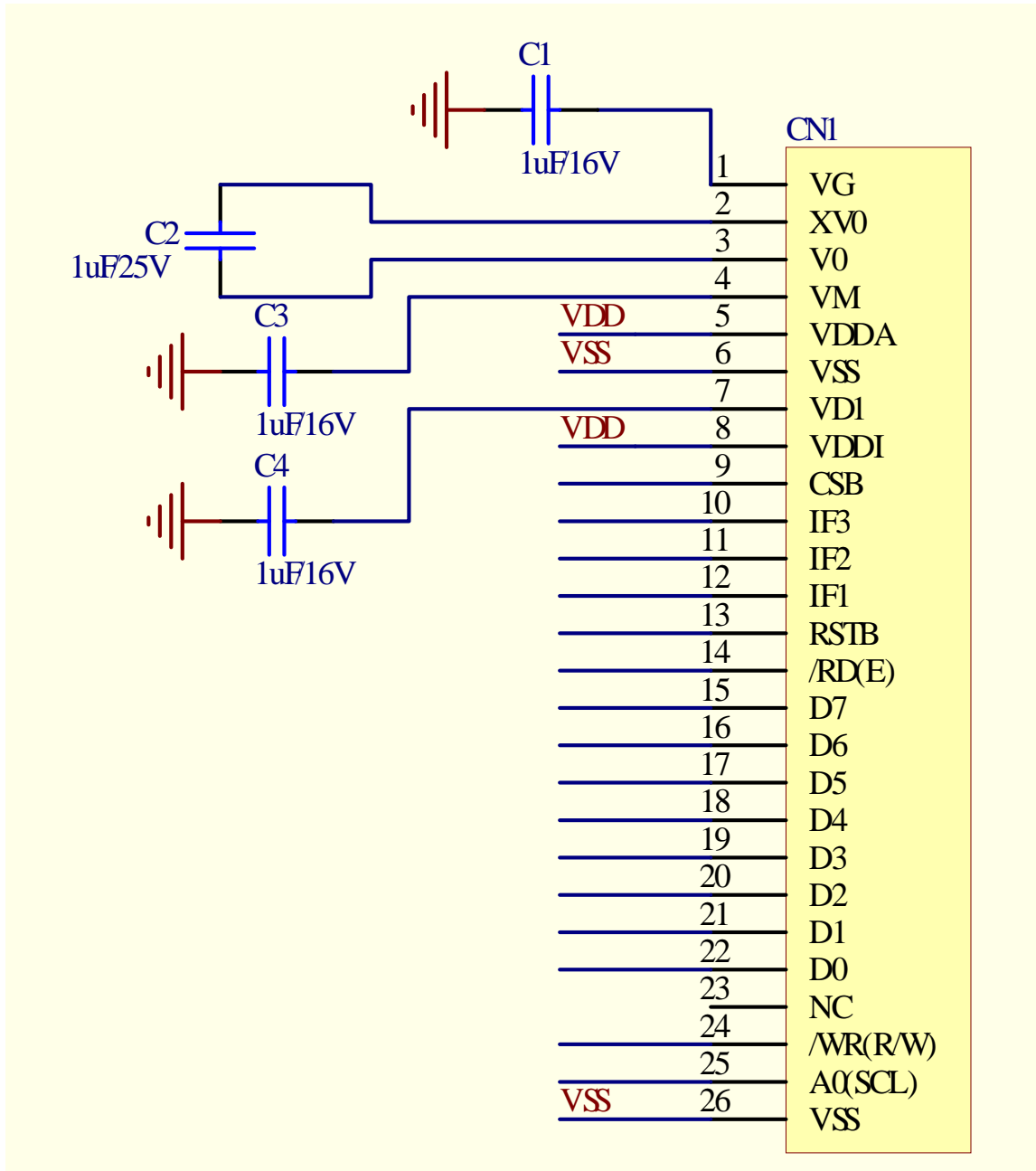



### 4. Optical Characteristics

Item	Symbol	Condition	Min	Typ	Max	Unit
View Angle	$\theta$	$CR \geq 2$	0	—	20	$\psi = 180^\circ$
	$\theta$	$CR \geq 2$	0	—	40	$\psi = 0^\circ$
	$\theta$	$CR \geq 2$	0	—	30	$\psi = 90^\circ$
	$\theta$	$CR \geq 2$	0	—	30	$\psi = 270^\circ$
Contrast Ratio	CR	—	—	3	—	—
Response Time	T rise	—	—	200	300	ms
	T fall	—	—	250	350	ms

#### Definition of Operation Voltage (Vop)

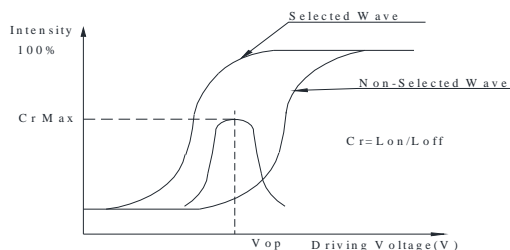
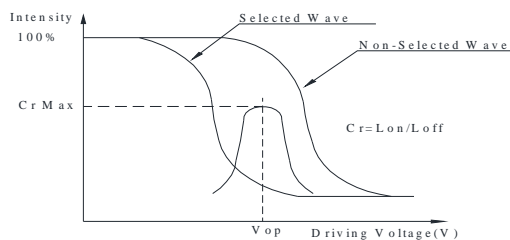

#### Definition of Response Time (Tr, Tf)

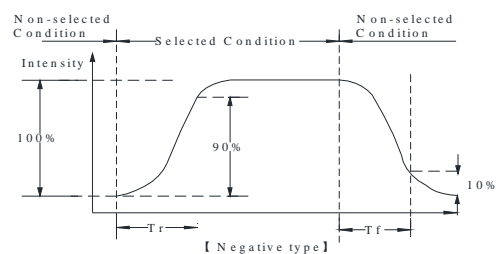
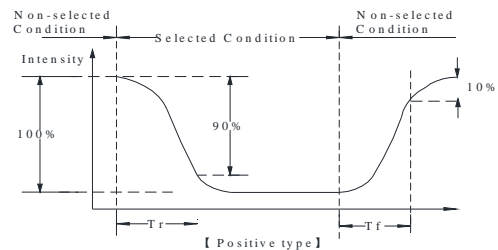

#### Conditions :

Operating Voltage : Vop      Viewing Angle( $\theta$  ,  $\phi$ ) :  $0^\circ$  ,  $0^\circ$   
 Frame Frequency : 64 HZ Driving Waveform : 1/N duty , 1/a bias

#### Definition of viewing angle( $CR \geq 2$ )

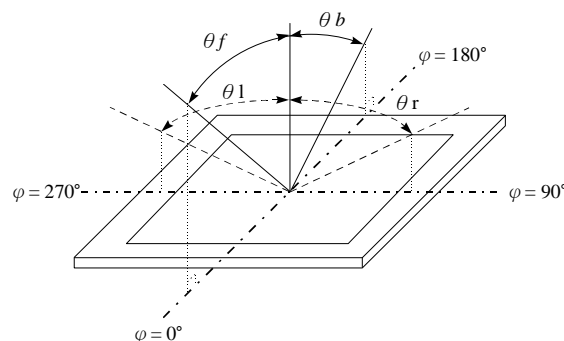

## 5. Absolute Maximum Ratings

Item	Symbol	Min	Typ	Max	Unit
Operating Temperature	T <sub>OP</sub>	-20	—	+70	°C
Storage Temperature	T <sub>ST</sub>	-30	—	+80	°C
Digital Power Supply Voltage	VDDI	-0.3	—	3.6	V
Analog Power Supply Voltage	VDDA	-0.3	—	3.6	V
LCD Power Supply Voltage	V0-XV0	-0.3	—	19	V
LCD Power Supply Voltage	VG	-0.3	—	5.5	V

## 6. Electrical Characteristics

Item	Symbol	Condition	Min	Typ	Max	Unit
Supply Voltage For Logic	$V_{DD-VSS}$	—	3.0	3.3	3.4	V
Supply Voltage For LCM	$V_0-XV_0$	Ta=-20°C	—	—	—	V
		Ta=25°C	9.8	10.0	10.2	V
		Ta=+70°C	—	—	—	V
Input High Volt.	$V_{IH}$	—	$0.7V_{DD}$	—	$V_{DD}$	V
Input Low Volt.	$V_{IL}$	—	VSS	—	$0.3 V_{DD}$	V
Output High Volt.	$V_{OH}$	—	$0.8 V_{DD}$	—	$V_{DD}$	V
Output Low Volt.	$V_{OL}$	—	VSS	—	$0.2V_{DD}$	V
Supply Current(No include LED Backlight)	$I_{DD}$	$V_{DD}=3.3V$	—	1.5	—	mA

Please kindly consider to design the Vop to be adjustable while programing the software to match LCD contrast tolerance.

## 7. Backlight Information

### Specification

PARAMETER	SYMBOL	MIN	TYP	MAX	UNIT	TEST CONDITION
Supply Current	I <sub>LED</sub>	—	112	140	mA	V= 3.5 V
Supply Voltage	V	3.3	3.5	3.7	V	—
Reverse Voltage	V <sub>R</sub>	—	—	5	V	—
Color Coordinate	X	0.26	0.29	0.32	—	—
	Y	0.27	0.30	0.33	—	—
Luminance (Without LCD)	I <sub>V</sub>	1440	1800	—	CD/M <sup>2</sup>	I <sub>LED</sub> = 112 mA
LED Life Time (For Reference only)	—	—	50K	—	Hr.	I <sub>LED</sub> = 112 mA 25°C,50-60%RH, (Note 1)
Color	White					

**Note:** The LED of B/L is drive by current only, drive voltage is for reference only. drive voltage can make driving current under safety area (current between minimum and maximum).

## 8. Reliability

### Content of Reliability Test (Wide temperature, -20°C~70°C)

Environmental Test			
Test Item	Content of Test	Test Condition	Note
High Temperature Storage	Endurance test applying the high storage temperature for a long time.	80°C 200hrs	2
Low Temperature Storage	Endurance test applying the low storage temperature for a long time.	-30°C 200hrs	1,2
High Temperature Operation	Endurance test applying the electric stress (Voltage & Current) and the thermal stress to the element for a long time.	70°C 200hrs	—
Low Temperature Operation	Endurance test applying the electric stress under low temperature for a long time.	-20°C 200hrs	1
High Temperature/ Humidity Storage	The module should be allowed to stand at 60°C,90%RH max For 96hrs under no-load condition excluding the polarizer, Then taking it out and drying it at normal temperature.	60°C,90%RH 96hrs	1,2
Thermal Shock Resistance	The sample should be allowed stand the following 10 cycles of operation -20°C    25°C    70°C  30min    5min    30min 1 cycle	-20°C/70°C 10 cycles	—
Vibration Test	Endurance test applying the vibration during transportation and using.	Total fixed amplitude : 1.5mm Vibration Frequency : 10~55Hz One cycle 60 seconds to 3 directions of X,Y,Z for Each 15 minutes	3
Static Electricity Test	Endurance test applying the electric stress to the terminal.	VS=±600V(contact), ±800V(air), RS=330Ω CS=150pF 10 times	—

**Note1: No dew condensation to be observed.**

**Note2: The function test shall be conducted after 4 hours storage at the normal Temperature and humidity after remove from the test chamber.**

**Note3: The packing have to including into the vibration testing.**

### 9. Inspection specification

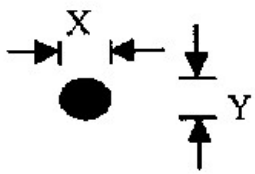
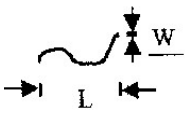
NO	Item	Criterion	AQL												
01	Electrical Testing	1.1 Missing vertical, horizontal segment, segment contrast defect. 1.2 Missing character , dot or icon. 1.3 Display malfunction. 1.4 No function or no display. 1.5 Current consumption exceeds product specifications. 1.6 LCD viewing angle defect. 1.7 Mixed product types. 1.8 Contrast defect.	0.65												
02	Black or white spots on LCD (display only)	2.1 White and black spots on display $\leq 0.25\text{mm}$ , no more than three white or black spots present. 2.2 Densely spaced: No more than two spots or lines within 3mm	2.5												
03	LCD black spots, white spots, contamination (non-display)	3.1 Round type : As following drawing $\Phi = (x + y) / 2$  <table border="1" data-bbox="821 981 1348 1236"> <thead> <tr> <th>SIZE</th> <th>Acceptable Q TY</th> </tr> </thead> <tbody> <tr> <td><math>\Phi \leq 0.10</math></td> <td>Accept no dense</td> </tr> <tr> <td><math>0.10 &lt; \Phi \leq 0.20</math></td> <td>2</td> </tr> <tr> <td><math>0.20 &lt; \Phi \leq 0.25</math></td> <td>1</td> </tr> <tr> <td><math>0.25 &lt; \Phi</math></td> <td>0</td> </tr> </tbody> </table>	SIZE	Acceptable Q TY	$\Phi \leq 0.10$	Accept no dense	$0.10 < \Phi \leq 0.20$	2	$0.20 < \Phi \leq 0.25$	1	$0.25 < \Phi$	0	2.5		
		SIZE	Acceptable Q TY												
$\Phi \leq 0.10$	Accept no dense														
$0.10 < \Phi \leq 0.20$	2														
$0.20 < \Phi \leq 0.25$	1														
$0.25 < \Phi$	0														
3.2 Line type : (As following drawing)  <table border="1" data-bbox="715 1482 1348 1729"> <thead> <tr> <th>Length</th> <th>Width</th> <th>Acceptable Q TY</th> </tr> </thead> <tbody> <tr> <td>---</td> <td><math>W \leq 0.02</math></td> <td>Accept no dense</td> </tr> <tr> <td><math>L \leq 3.0</math></td> <td><math>0.02 &lt; W \leq 0.03</math></td> <td rowspan="2">2</td> </tr> <tr> <td><math>L \leq 2.5</math></td> <td><math>0.03 &lt; W \leq 0.05</math></td> </tr> <tr> <td>---</td> <td><math>0.05 &lt; W</math></td> <td>As round type</td> </tr> </tbody> </table>	Length	Width	Acceptable Q TY	---	$W \leq 0.02$	Accept no dense	$L \leq 3.0$	$0.02 < W \leq 0.03$	2	$L \leq 2.5$	$0.03 < W \leq 0.05$	---	$0.05 < W$	As round type	2.5
Length	Width	Acceptable Q TY													
---	$W \leq 0.02$	Accept no dense													
$L \leq 3.0$	$0.02 < W \leq 0.03$	2													
$L \leq 2.5$	$0.03 < W \leq 0.05$														
---	$0.05 < W$	As round type													
04	Polarizer Bubbles	If bubbles are visible, judge using black spot specifications, not easy to find, must check in specify direction. <table border="1" data-bbox="842 1803 1348 2101"> <thead> <tr> <th>Size <math>\Phi</math></th> <th>Acceptable Q TY</th> </tr> </thead> <tbody> <tr> <td><math>\Phi \leq 0.20</math></td> <td>Accept no dense</td> </tr> <tr> <td><math>0.20 &lt; \Phi \leq 0.50</math></td> <td>3</td> </tr> <tr> <td><math>0.50 &lt; \Phi \leq 1.00</math></td> <td>2</td> </tr> <tr> <td><math>1.00 &lt; \Phi</math></td> <td>0</td> </tr> <tr> <td>Total Q TY</td> <td>3</td> </tr> </tbody> </table>	Size $\Phi$	Acceptable Q TY	$\Phi \leq 0.20$	Accept no dense	$0.20 < \Phi \leq 0.50$	3	$0.50 < \Phi \leq 1.00$	2	$1.00 < \Phi$	0	Total Q TY	3	2.5
Size $\Phi$	Acceptable Q TY														
$\Phi \leq 0.20$	Accept no dense														
$0.20 < \Phi \leq 0.50$	3														
$0.50 < \Phi \leq 1.00$	2														
$1.00 < \Phi$	0														
Total Q TY	3														

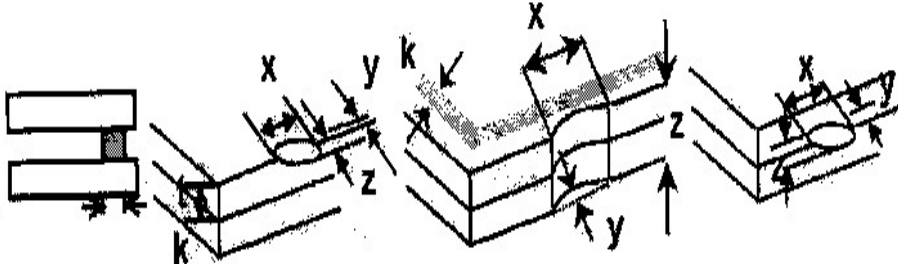
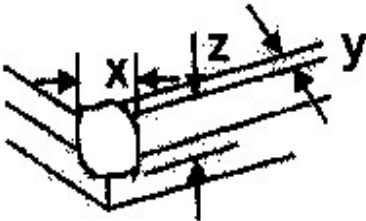
NO	Item	Criterion	AQL																		
05	Scratches	Follow NO.3 LCD black spots, white spots, contamination																			
06	Chipped Glass	<p>Symbols Define:                      x: Chip length      y: Chip width      z: Chip thickness                      k: Seal width      t: Glass thickness      a: LCD side length                      L: Electrode pad length:</p> <p>6.1 General glass chip :                      6.1.1 Chip on panel surface and crack between panels:</p>  <table border="1" data-bbox="459 972 1369 1182"> <thead> <tr> <th>z: Chip thickness</th> <th>y: Chip width</th> <th>x: Chip length</th> </tr> </thead> <tbody> <tr> <td><math>Z \leq 1/2t</math></td> <td>Not over viewing area</td> <td><math>x \leq 1/8a</math></td> </tr> <tr> <td><math>1/2t &lt; z \leq 2t</math></td> <td>Not exceed 1/3k</td> <td><math>x \leq 1/8a</math></td> </tr> </tbody> </table> <p>⊙ If there are 2 or more chips, x is total length of each chip.</p> <p>6.1.2 Corner crack:</p>  <table border="1" data-bbox="459 1615 1369 1825"> <thead> <tr> <th>z: Chip thickness</th> <th>y: Chip width</th> <th>x: Chip length</th> </tr> </thead> <tbody> <tr> <td><math>Z \leq 1/2t</math></td> <td>Not over viewing area</td> <td><math>x \leq 1/8a</math></td> </tr> <tr> <td><math>1/2t &lt; z \leq 2t</math></td> <td>Not exceed 1/3k</td> <td><math>x \leq 1/8a</math></td> </tr> </tbody> </table> <p>⊙ If there are 2 or more chips, x is the total length of each chip.</p>	z: Chip thickness	y: Chip width	x: Chip length	$Z \leq 1/2t$	Not over viewing area	$x \leq 1/8a$	$1/2t < z \leq 2t$	Not exceed 1/3k	$x \leq 1/8a$	z: Chip thickness	y: Chip width	x: Chip length	$Z \leq 1/2t$	Not over viewing area	$x \leq 1/8a$	$1/2t < z \leq 2t$	Not exceed 1/3k	$x \leq 1/8a$	2.5
z: Chip thickness	y: Chip width	x: Chip length																			
$Z \leq 1/2t$	Not over viewing area	$x \leq 1/8a$																			
$1/2t < z \leq 2t$	Not exceed 1/3k	$x \leq 1/8a$																			
z: Chip thickness	y: Chip width	x: Chip length																			
$Z \leq 1/2t$	Not over viewing area	$x \leq 1/8a$																			
$1/2t < z \leq 2t$	Not exceed 1/3k	$x \leq 1/8a$																			

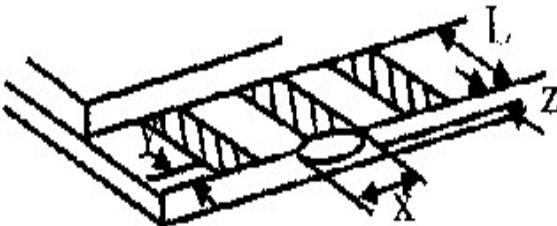
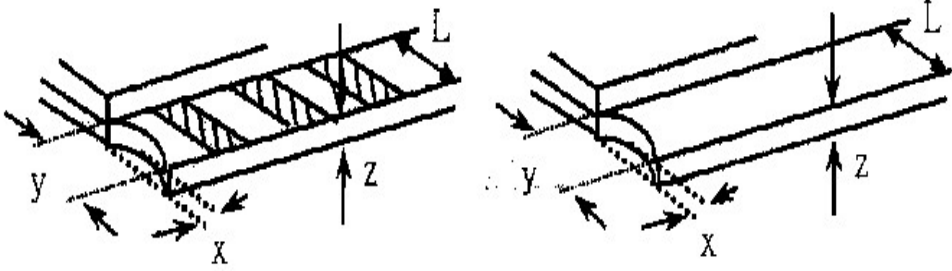
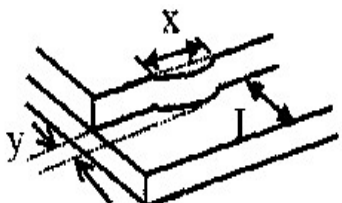
NO	Item	Criterion	AQL							
06	Glass Crack	<p>Symbols :</p> <p>x: Chip length      y: Chip width      z: Chip thickness</p> <p>k: Seal width      t: Glass thickness      a: LCD side length</p> <p>L: Electrode pad length</p> <p>6.2 Protrusion over terminal :</p> <p>6.2.1 Chip on electrode pad :</p>  <table border="1" data-bbox="379 801 1300 907"> <thead> <tr> <th>y: Chip width</th> <th>x: Chip length</th> <th>z: Chip thickness</th> </tr> </thead> <tbody> <tr> <td><math>y \leq 0.5\text{mm}</math></td> <td><math>x \leq 1/8a</math></td> <td><math>0 &lt; z \leq t</math></td> </tr> </tbody> </table>	y: Chip width	x: Chip length	z: Chip thickness	$y \leq 0.5\text{mm}$	$x \leq 1/8a$	$0 < z \leq t$	2.5	
		y: Chip width	x: Chip length	z: Chip thickness						
$y \leq 0.5\text{mm}$	$x \leq 1/8a$	$0 < z \leq t$								
<p>6.2.2 Non-conductive portion:</p>  <table border="1" data-bbox="450 1288 1276 1400"> <thead> <tr> <th>y: Chip width</th> <th>x: Chip length</th> <th>z: Chip thickness</th> </tr> </thead> <tbody> <tr> <td><math>y \leq L</math></td> <td><math>x \leq 1/8a</math></td> <td><math>0 &lt; z \leq t</math></td> </tr> </tbody> </table> <p>⊙ If the chipped area touches the ITO terminal, over 2/3 of the ITO must remain and be inspected according to electrode terminal specifications.</p> <p>⊙ If the product will be heat sealed by the customer, the alignment mark not be damaged.</p> <p>6.2.3 Substrate protuberance and internal crack.</p>  <table border="1" data-bbox="790 1702 1348 1803"> <thead> <tr> <th>y: width</th> <th>x: length</th> </tr> </thead> <tbody> <tr> <td><math>y \leq 1/3L</math></td> <td><math>x \leq a</math></td> </tr> </tbody> </table>	y: Chip width	x: Chip length	z: Chip thickness	$y \leq L$	$x \leq 1/8a$	$0 < z \leq t$	y: width	x: length	$y \leq 1/3L$	$x \leq a$
y: Chip width	x: Chip length	z: Chip thickness								
$y \leq L$	$x \leq 1/8a$	$0 < z \leq t$								
y: width	x: length									
$y \leq 1/3L$	$x \leq a$									

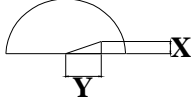

NO	Item	Criterion	AQL
07	Cracked Glass	The LCD with extensive crack is not acceptable.	2.5
08	Backlight Elements	8.1 Illumination source flickers when lit.	0.65
		8.2 Spots or scratched that appear when lit must be judged. Using LCD spot, lines and contamination standards.	2.5
		8.3 Backlight doesn't light or color wrong.	0.65
09	Bezel	9.1 Bezel may not have rust, be deformed or have fingerprints, stains or other contamination.	2.5
		9.2 Bezel must comply with job specifications.	0.65
10	PCB · COB	10.1 COB seal may not have pinholes larger than 0.2mm or contamination.	2.5
		10.2 COB seal surface may not have pinholes through to the IC.	2.5
		10.3 The height of the COB should not exceed the height indicated in the assembly diagram.	0.65
		10.4 There may not be more than 2mm of sealant outside the seal area on the PCB. And there should be no more than three places.	2.5
		10.5 No oxidation or contamination PCB terminals.	2.5
		10.6 Parts on PCB must be the same as on the production characteristic chart. There should be no wrong parts, missing parts or excess parts.	0.65
		10.7 The jumper on the PCB should conform to the product characteristic chart.	0.65
		10.8 If solder gets on bezel tab pads, LED pad, zebra pad or screw hold pad, make sure it is smoothed down.	2.5
		10.9 The Scraping testing standard for Copper Coating of PCB	2.5
		 <p style="text-align: center;"><math>X * Y \leq 2\text{mm}^2</math></p>	
11	Soldering	11.1 No un-melted solder paste may be present on the PCB.	2.5
		11.2 No cold solder joints, missing solder connections, oxidation or icicle.	2.5
		11.3 No residue or solder balls on PCB.	2.5
		11.4 No short circuits in components on PCB.	0.65

NO	Item	Criterion	AQL
12	General Appearance	12.1 No oxidation, contamination, curves or, bends on interface Pin (OLB) of TCP.	2.5
		12.2 No cracks on interface pin (OLB) of TCP.	0.65
		12.3 No contamination, solder residue or solder balls on product.	2.5
		12.4 The IC on the TCP may not be damaged, circuits.	2.5
		12.5 The uppermost edge of the protective strip on the interface pin must be present or look as if it cause the interface pin to sever.	2.5
		12.6 The residual rosin or tin oil of soldering (component or chip component) is not burned into brown or black color.	2.5
		12.7 Sealant on top of the ITO circuit has not hardened.	0.65
		12.8 Pin type must match type in specification sheet.	0.65
		12.9 LCD pin loose or missing pins.	0.65
		12.10 Product packaging must the same as specified on packaging specification sheet.	0.65
		12.11 Product dimension and structure must conform to product specification sheet.	0.65
		12.12 Visual defect outside of VA is not considered to be rejection.	

## **10. Precautions in use of LCD Modules**

- (1) Avoid applying excessive shocks to the module or making any alterations or modifications to it.
- (2) Don't make extra holes on the printed circuit board, modify its shape or change the components of LCD module.
- (3) Don't disassemble the LCM.
- (4) Don't operate it above the absolute maximum rating.
- (5) Don't drop, bend or twist LCM.
- (6) Soldering: only to the I/O terminals.
- (7) Storage: please storage in anti-static electricity container and clean environment.
- (8) Display Elektronik GmbH have the right to change the passive components, including R3,R6 & backlight adjust resistors. (Resistors,capacitors and other passive components will have different appearance and color caused by the different supplier.)
- (9) Display Elektronik GmbH have the right to change the PCB Rev. (In order to satisfy the supplying stability, management optimization and the best product performance...etc, under the premise of not affecting the electrical characteristics and external dimensions, Display Elektronik GmbH have the right to modify the version.)
- (10) To ensure the stability of the display screen, please apply screen saver after showing 30 mins of fixed display content.
- (11) The limitation of FPC bending

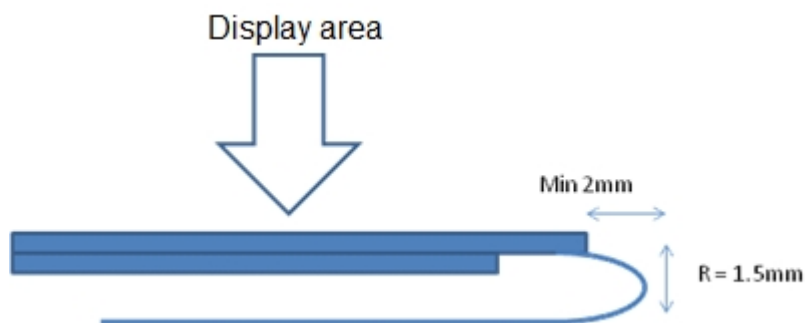

## 11. Material List of Components for RoHs

1. Display Elektronik GmbH hereby declares that all of or part of products (with the mark “#”in code), including, but not limited to, the LCM, accessories or packages, manufactured and/or delivered to your company (including your subsidiaries and affiliated company) directly or indirectly by our company (including our subsidiaries or affiliated companies) do not intentionally contain any of the substances listed in all applicable EU directives and regulations, including the following substances.

Exhibit A : The Harmful Material List

Material	Cd	Pb	Hg	Cr6+	PBB	PBDE	DEHP	BBP	DBP	DIBP
Limited Value	100 ppm	1000 ppm	1000 ppm	1000 ppm	1000 ppm	1000 ppm	1000 ppm	1000 ppm	1000 ppm	1000 ppm
Above limited value is set up according to RoHS.										

2.Process for RoHS requirement : (only for RoHS inspection)

- (1) Use the Sn/Ag/Cu soldering surface ; the surface of Pb-free solder is rougher than we used before.
- (2) Heat-resistance temp. :  
 Reflow : 250°C,30 seconds Max. ;  
 Connector soldering wave or hand soldering : 320°C, 10 seconds max.
- (3) Temp. curve of reflow, max. Temp. : 235±5°C ;  
 Recommended customer’s soldering temp. of connector : 280°C, 3 seconds.

## 12. Recommendable Storage

1. Place the panel or module in the temperature 25°C±5°C and the humidity below 65% RH
2. Do not place the module near organics solvents or corrosive gases.
3. Do not crush, shake, or jolt the module.

**13. Initial code**

```
void initial()
{

    RES=1;
    Delay_ms(120);
    RES=0;
    Delay_ms(10);
    RES=1;
    Delay_ms(120);

    write_com(0xD7);    // Disable Auto Read
    write_dat(0x9F);

    write_com(0xE0);    // Enable OTP Read
    write_dat(0x00);
    Delay_ms(10);

    write_com(0xE3);    // OTP Up-Load
    Delay_ms(20);

    write_com(0xE1);    // OTP Control Out

    write_com(0x11);    // Sleep Out

    write_com(0x28);    // Display OFF
    Delay_ms(50);

    write_com(0xC0);    // Set Vop
    write_dat(0xA0);    //
    write_dat(0x00);    //

    write_com(0xC3);    // BIAS System
    write_dat(0x05);    //

    write_com(0xC4);    // Booster Level
    write_dat(0x05);

    write_com(0xD0);    // Enable Analog Circuit
    write_dat(0x1D);

    write_com(0xB5);    // N-Line Inversion
    write_dat(0x00);    //

    write_com(0x39);    // Display Mode

    write_com(0xF1);    // Frame Rate (Monochrome Mode)
    write_dat(0x06);    //
    write_dat(0x0B);    //
    write_dat(0x0D);    //
```

```
write_dat(0x10);    //

write_com(0x3A);    // Enable DDRAM Interface
write_dat(0x02);

    write_com(0x36);    // Display Control
write_dat(0xC8);    //

write_com(0xB0);    // Display Duty
write_dat(0x3F);    //

write_com(0x20);    // Inverse Display

write_com(0x37);    // Start Line
write_dat(0x00);    //

write_com(0xB1);    // First Output COM
write_dat(0x00);    //

write_com(0xB3);    // FOSC Divider
write_dat(0x00);

write_com(0x2A);    // Set Column Address
write_dat(0x00);    //
write_dat(48);      //
write_dat(0x00);    //
write_dat(127);     //

write_com(0x2B);    // Set Row Address
write_dat(0x00);    //
write_dat(96);      //
write_dat(0x00);    //
write_dat(159);     //

write_com(0xC4);    // Booster Level
write_dat(0x07);

write_com(0x29);    // Display ON
}
```